

KNX VOC/TH-UP Touch Combined Indoor Sensor

Technical specifications and installation instructions

Item numbers 70970 (white), 70973 (black)

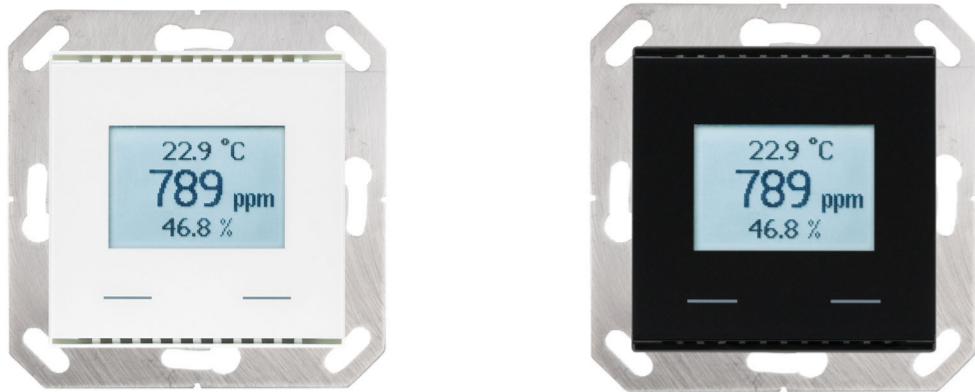

1. Description

The **Sensor KNX VOC/TH-UP Touch** measures volatile organic compounds in the room air, temperature and humidity and calculates the dew point. The sensor can receive external measured values via the bus and process them with the own data to overall values (mixed values, e. g. room average). The **KNX VOC/TH-UP Touch** offers two push buttons that may be used for changing the ambient temperature (target value), for switching between operating modes or as free programmable bus push buttons.

The **KNX VOC/TH-UP Touch** provides switching outputs with adjustable threshold values. The switching outputs and further communication objects can be linked by AND and OR logic gates. Additionally, an integrated actuating variable comparator can compare and output values that are received via communication objects.

Integrated PI controllers allows for control of a ventilation (depending on VOC concentration and air humidity) and a heating/cooling system (depending on temperature). The **KNX VOC/TH-UP Touch** can emit a warning to the bus as soon as the area of optimum comfort (according to DIN 1946) is left.

The integrated display shows the own values and data received from the bus (e.g. date, time). The device is completed with a frame of the switching series installed in the building and thus merges with the interior.

Functions:

- Measurement of **VOC** (volatile organic compounds) in the air. In this process, an air quality value in CO₂ equivalents is calculated via an algorithm from the sum signal of all compounds included in the mixed gas.
- Measurement of **temperature** and **air humidity** (absolute and relative), calculation of the dew point
- **Mixed values** from own measured values and external values (proportions can be set in percentage)
- **Display** 1-3 rows (own values or values received from the bus) or display of temperature control (see *Mode display and manual temperature controller*)
- **2 push buttons**. Configuration as bus push button or for changing ambient temperature and switching between operating modes (see *Change ambient temperature with the buttons*)
- **PI controller for heating** (one or two step) and **cooling** (one or two step) depending on temperature. Control according to separate target values or basic target temperature
- **PI controller for ventilation** depending on humidity and VOC concentration: dehumidification/humidification (one step) or dehumidification (one or two step)
- **Threshold values** can be adjusted per parameter or via communication objects: 3 x temperature, 2 x humidity, 4 x VOC
- **4 AND and 4 OR logic gates** with each 4 inputs. Every switching incident as well as 16 logic inputs in the form of communication objects, may be used as inputs for the logic gates. The output of each gate may optionally be configured as 1 bit or 2 x 8 bits
- **2 actuating variable comparators** for output of minimum, maximum or average values. Each with 5 inputs (for values received via communication objects)

Configuration is made using the KNX software ETS 5. The **product file** can be downloaded from the ETS online catalogue and the Elsner Elektronik website on www.elsner-elektronik.de in the "Service" menu.

1.1. Scope of delivery

- Housing with display
- Base plate

You will need *in addition* (not supplied):

- Socket Ø 60 mm, 42 mm deep
- Frame (for element 55 x 55 mm), suitable for the switching programme used in the building

1.2. Technical specifications

Housing	Plastic material
Colours	<ul style="list-style-type: none"> • similar to RAL 9005 jet black • similar to RAL 9010 pure white

Mounting	In-wall (wall mounting in socket Ø 60 mm, 42 mm deep, resp. cavity wall socket for hole Ø 68 mm)
Protection category	IP 20
Dimensions	Housing approx. 55 x 55 (W x H, mm), mounting depth approx. 8 mm, base plate approx. 71 x 71 (W x H, mm)
Total weight	approx. 68 g
Ambient temperature	Operation 0...+50°C, storage -10...+60°C
Ambient air humidity	min. 10% RH, max. 95% RH, avoid bedewing
Operating voltage	KNX bus voltage
Bus current	max. 20 mA
Data output	KNX +/- bus terminal plug
BCU type	Own micro controller
PEI type	0
Group addresses	max. 254
Allocations	max. 254
Communication objects	224
VOC measurement range	400...2000 ppm
VOC resolution	1 ppm
Temperature measurement range	0...+50°C
Temperature resolution	0.1°C
Temperature accuracy	± 0.5°C at 0...+50°C (Mind the notes on <i>Accuracy of the measurement</i>)
Humidity measurement range	0% RH ...95% RH
Humidity resolution	0.1%
Humidity accuracy	±7.5% RH at 0...10% RH ±4.5% RH at 10...90% RH ±7.5% RH at 90...95% RH
Humidity drift	± 0.5% RH per year in normal air

The product conforms with the provisions of EU guidelines.

1.2.1. Accuracy of the measurement

Measurement variations from permanent sources of interference (see chapter *Installation position*) can be corrected in the ETS in order to ensure the specified accuracy of the sensor (offset).

To ensure a correct **VOC measurement**, the device must be installed in a windproof socket.

When **measuring temperature**, the self-heating of the device is considered by the electronics. The heating is compensated by the software.

1.2.2. Measuring ranges of different gases (CO₂ equivalents)

Corresponding VOC concentrations for specific representatives

Compound	Formula	Range* (ppm)	Potential sources of pollutants indoors
Carbon monoxide	CO	0-10	Car exhaust, fuel-based heating, cooking appliances, smoking
Methane	CH ₄	0-200	Natural gas
Propane	C ₃ H ₈	0-20	Fuel-based heating, cooking appliances, cleaners
Ethyl alcohol	C ₂ H ₆ O	0-3	Cosmetics, cleaners, disinfectants, detergents, paints, coatings, breath
Acetaldehyde	C ₂ H ₄ O	0-20	Adhesives, coatings, plastics, lubricants, ripening of fruits
Methylethylketone	C ₄ H ₈ O	0-20	Adhesives, coatings, plastics, lubricants
Toluene	C ₇ H ₈	0-5	Paints, coatings, cleaners, detergents, smoking, polyurethane lacquers

* corresponding concentration range based on lab measurements at gas mixing system with synthetic air at 50% r.h. and RT

2. Installation and commissioning

2.1. Installation notes



Installation, testing, operational start-up and troubleshooting should only be performed by an electrician.



CAUTION! Live voltage!

- There are unprotected live components inside the device.
- National legal regulations are to be followed.
 - Ensure that all lines to be assembled are free of voltage and take precautions against accidental switching on.
 - Do not use the device if it is damaged.
 - Take the device or system out of service and secure it against unintentional use, if it can be assumed, that risk-free operation is no longer guaranteed.

The device is only to be used for its intended purpose. Any improper modification or failure to follow the operating instructions voids any and all warranty and guarantee claims.

After unpacking the device, check it immediately for possible mechanical damage. If it has been damaged in transport, inform the supplier immediately.

The device may only be used as a fixed-site installation; that means only when assembled and after conclusion of all installation and operational start-up tasks and only in the surroundings designated for it.

Elsner Elektronik is not liable for any changes in norms and standards which may occur after publication of these operating instructions.

2.2. Installation position

The **Sensor KNX VOC/TH-UP Touch** is made for wall mounting in a socket (Ø 60 mm, 42 mm deep).

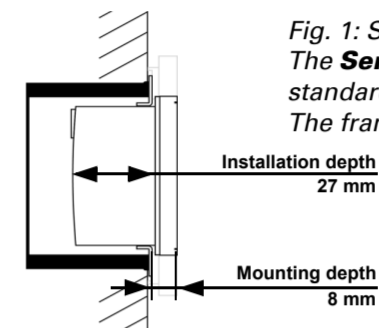

Fig. 1: Sectional drawing.
The **Sensor KNX VOC/TH-UP Touch** fits into a standard socket (Ø 60 mm, depth 42 mm).
The frame is not included!



May be installed and operated in dry interior rooms only. Avoid condensation.

When selecting an installation location, please ensure that the measurement results are affected as little as possible by external influences. Possible sources of interference include:

- Direct sunlight
- Drafts from windows and doors
- Draft from ducts which lead from other rooms or from the outside to the junction box in which the sensor is mounted
- Warming or cooling of the building structure on which the sensor is mounted, e.g. due to sunlight, heating or cold water pipes
- Connection lines and ducts which lead from warmer or colder areas to the sensor

Measurement variations from permanent sources of interference can be corrected in the ETS in order to ensure the specified accuracy of the sensor (offset).

To ensure a correct VOC measurement, the device must be installed in a windproof socket.

2.3. Composition

2.3.1. Housing

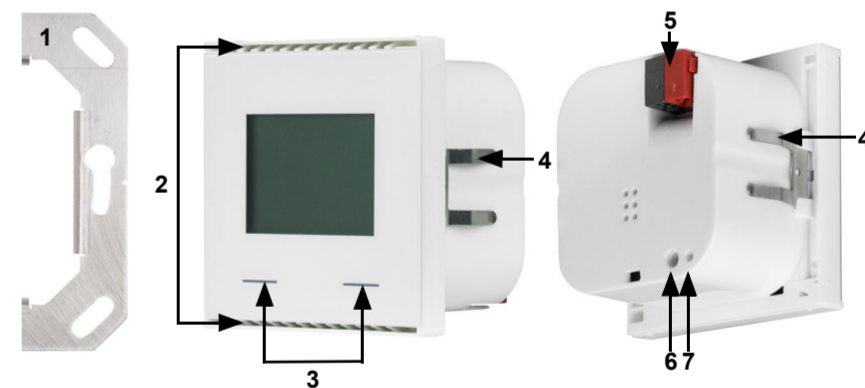

Fig. 2

- 1 Base plate
- 2 Openings for air circulation
- 3 Touch sensitive buttons
- 4 Catches
- 5 KNX terminal BUS +/-
- 6 Programming button (recessed) for teaching device
- 7 Programming LED (recessed)

2.4. Assembly of the sensor

First of all fit the windproof socket with connection. Also seal inlet pipes to avoid infiltration.

Screw the base plate onto the socket and position the frame of the switching programme. Connect the bus line +/- to the black-red plug.

Pin the housing with the notches on to the metal frame, so that device and frame are fixed.

2.5. Notes on mounting and commissioning

Never expose the device to water (e.g. rain) or dust. This can damage the electronics. You must not exceed a relative humidity of 95%. Avoid condensation.

After the bus voltage has been applied, the device will enter an initialisation phase lasting a few seconds. During this phase no information can be received or sent via the bus.

3. Addressing of the device at the bus

The device is supplied with the bus address 15.15.255. You can program another address into the ETS by overwriting the 15.15.255 address or by teaching via the programming button.

4. Display and operation at the device

Detailed specifications for the display and the use of the push buttons are set in the ETS.

Basically the display can show a two-row or three-row text (e. g. for measured values) or a temperature controller. You can switch between the two types by pressing one of the buttons, if this has not been disabled in the ETS.

4.1. Mode display and manual temperature controller

Depending on the ETS setting selected, the mode display will only display show the current target value, or the base target value setting with scale display. The manually adjustable range can be set in the ETS.

The following display options are available:



Fig. 3
Mode display with current target value and/or base target value

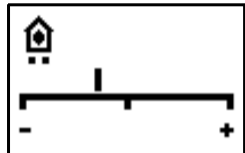

Fig. 4
Mode display with scale display for adjusting the base target value. The control position in the image reads "Base target value reduced".

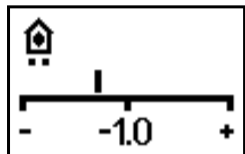

Fig. 5
Mode display with scale display and number. Shows the set target value change. The control position in the image reads "Base target value reduced to 1.0°".

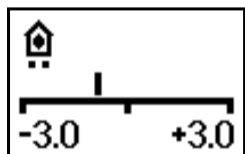

Fig. 6
Mode display with scale display and range. Shows the possible adjustment range (as set in the ETS). The control position in the image reads "Base target value reduced".

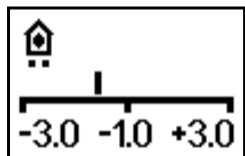

Fig. 7
Mode display with scale display, range and number. Displays the possible adjustment range (as set in the ETS) and the set target value change. The control position in the image reads "Base target value reduced to 1.0°".

Symbols

	Comfort mode. Comfort (present) target temperature will be used.		Standby mode. Standby (absent during day) target temperature will be used.
	Eco mode. Night target temperature will be used.		Building protection mode. Building protection target temperature will be used. The symbol will blink when the mode has been activated but the activation delay has not yet expired.
	Heating mode. Heating will be provided.		Cooling mode. Cooling will be provided.

Priority (points)

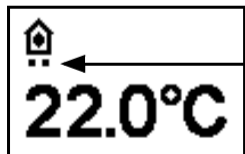

Fig. 8
In "HVAC mode with 2x 8 bits" control mode, points are shown under the symbol, to indicate the running priority of the current mode.

One point: Priority 1/priority control. It is not possible to adjust the temperature automation system manually. Neither the target temperature nor the operating modes can be changed using the buttons on the unit.

Two points: Priority 2. The target temperature and operating mode can be changed using the buttons.

4.2. Change ambient temperature with the buttons

If the mode display is active, the target ambient temperature and the operating mode can be changed manually using the buttons. The button functions can be blocked in the ETS or be suppressed for Priority 1 operating modes. The individual operating modes can also be locked for manual selection in the ETS.

Decrease target temperature (-)	briefly press left button	Ambient temperature in the current mode is decreased. The sep-size is defined in the ETS (0.1°C to 5°C).
Increase target temperature (+)	briefly press right button	Ambient temperature in the current mode is increased. The sep-size is defined in the ETS (0.1°C to 5°C).
Change mode	press left or right button longer than 2 secs.	Changes between the operating modes Comfort, Standby, Eco and Building Protection (if deblocked in the ETS).
Extend Comfort mode	in Eco mode: press both buttons at the same time longer than 2 secs.	Switches from Eco to Comfort mode again for a certain time (e. g. if the rooms are used longer in the evening). The period is defined in the ETS (up to 10 hours). The time remaining in Comfort mode is displayed.